



Solitel® Vibrating Rod Level Switch

DESCRIPTION

Solitel Vibrating Rod Level Switches provide reliable level detection of powders and bulk solids. This compact, integral switch is suitable for high or low level detection in hoppers or silos. It may also be used for plugged chute detection.

The single-piece probe and the unique self-clean cycle avoid problems of buildup. Sensitivity of the instrument can be adjusted to detect a variety of solid materials ranging from heavy granular materials to light powders with bulk densities less than one pound per cubic foot.

TECHNOLOGY

The Solitel rod vibrates at a frequency of 350 Hz. When in contact with the media, the vibration is dampened. The attenuation of the vibration is detected by the integral mount electronics which change the state of the relay. The unique self-clean feature is activated when the vibration is dampened. The self-clean circuitry increases the amplitude of the vibration to dislodge any build-up which may have occurred.

FEATURES

- Single rod design eliminates clogging
- High temperature version up to 320° F (160° C)
- Self-clean cycle and polished probe minimize solids build-up
- Class I, Div. 2 and Class II, Div. 1 approval
- Adjustable sensitivity adjustment allows easy calibration for various bulk densities
- Extended rigid probes up to 100 inches (2540 mm)
- Extended flexible lengths to 65 feet (20 meters)



APPLICATIONS

Powders and bulk solids with maximum particle size of ½ inch (10 mm) including:

- Plastic powders and pellets
- Wood chips and sawdust
- Pulverized coal
- Fly ash
- Cement, lime
- Perlite
- Aerosil (fume silica)

SPECIFICATIONS

Input voltage	110 VAC +10/-15%
	220 VAC +10/-15%
	24 VDC (±10%)
Power consumption	Less than or equal to 3 VA
Operation frequency	350 Hz
Output relay	SPDT 8 amp @ 250 VAC (resistive)
	SPDT 1 amp @ 24 VDC (resistive)
Time delay	4 to 10 seconds (depending on sensitivity adjustment)
Process connection	1½" NPT
Housing	NEMA 4X, 9
Operating process temperature	Standard: -4° to +230° F (-20° to +110° C)
	Enhanced performance: -40° to +320° F (-40° to +160° C)
Ambient electronics temperature	-40° to +140° F (-40° to +60° C), refer to chart below
Relative humidity	98%
Maximum process pressure	360 PSIG
Materials	Vibrating rod: 316 stainless steel
	Rigid extension: 316 stainless steel
Cable for flexible probe	Polyethylene coated steel
Insertion length	Standard VXH: 8.25 inches (209 mm)
	Extended rigid probe VXR: 10 to 100 inches (25 to 254 cm)
	Extended flexible probe V XK: 3 to 65 feet (1 to 20 meters)

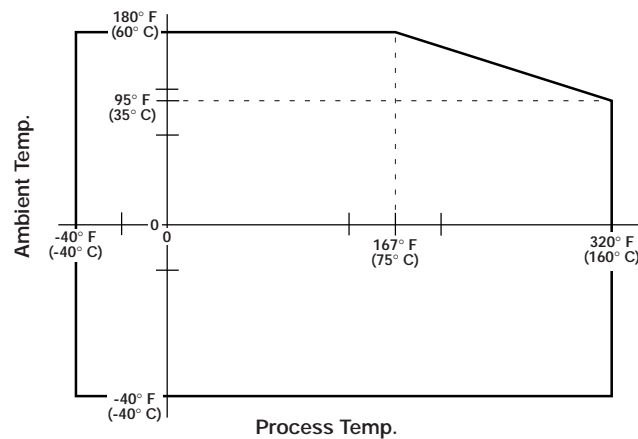

AGENCY APPROVALS

AGENCY	MODEL APPROVED	APPROVAL CLASSES
CSA	VXX-D1BX-XXX	Class I, Div. 2; Groups A, B, C, & D Class II, Div. 1; Group E, F, & G, TYPE 4X



These units have been tested to EN 50081-2 and EN 50082-2 and are in compliance with the EMC Directive 89/336/EEC.



These units have been evaluated to the applicable UL and CSA standards. CSA is accredited as a NRTL (National Recognized Testing Laboratory) in the United States.

MODEL NUMBER

STANDARD & EXTENDED RIGID

DESIGN TYPE

1	Standard, -4° to +230° F (-20° to +110° C), insertion length in inches
2	Enhanced performance, -40° to +320° F (-40° to +160° C), insertion length in inches
3	Standard, -4° to +230° F (-20° to +110° C), insertion length in centimeters
4	Enhanced performance, -40° to +320° F (-40° to +160° C), insertion length in centimeters

PROBE TYPE

H	Standard rigid probe, 8.25" insertion length
R	Extended rigid probe, see "Insertion length" below

INPUT VOLTAGE

0	110 VAC
1	220 VAC
2	24 VDC

INSERTION LENGTH

Probe Type Code R, Design Type Code 1 or 2 Length in inches from 10 to 100 inches (example: 10 inches = Code 010)
Probe Type Code R, Design Type Code 3 or 4 Length in centimeters from 25 to 254 cm (example 25 cm = Code 025)
Probe Type Code H, Design Type Code 1 or 3 Specify Code 000
Probe Type Code H, Design Type Code 2 or 4 Specify Code 000

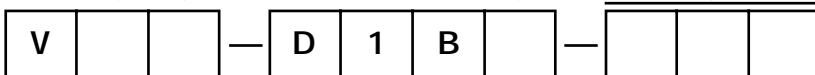

MODEL NUMBER

EXTENDED FLEXIBLE

DESIGN TYPE

1	Standard, -4° to +230° F (-20° to +110° C), insertion length in feet
3	Standard, -4° to +230° F (-20° to +110° C), insertion length in meters

INPUT VOLTAGE

0	110 VAC
1	220 VAC
2	24 VDC

INSERTION LENGTH

Design Type Code 1
Length in feet from 3 to 65 feet (example: 10 feet = Code 010)
Design Type Code 3
Length in meters from 1 to 20 meters (example 15 meters = Code 015)

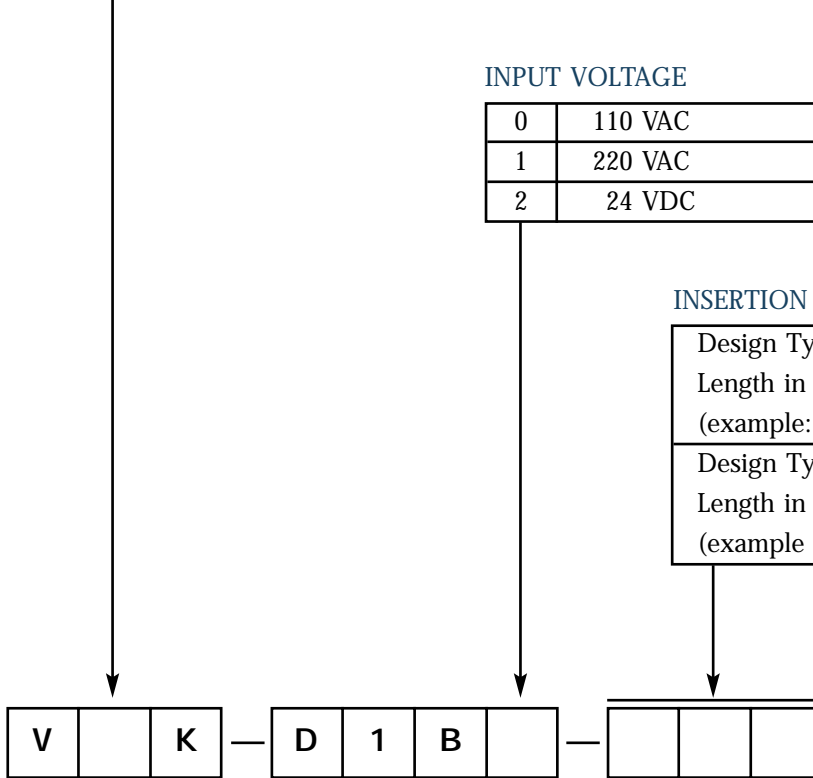

DIMENSIONAL SPECIFICATIONS

INCHES (m m)

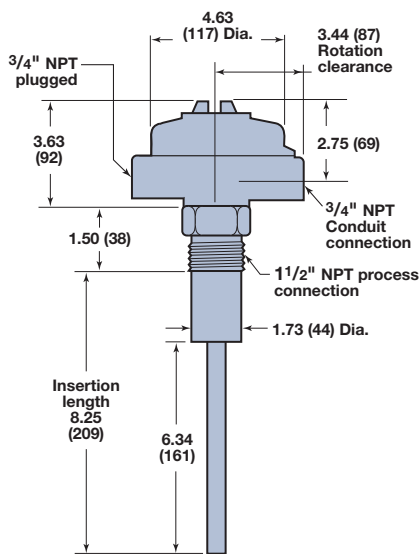

Standard Rigid Probe

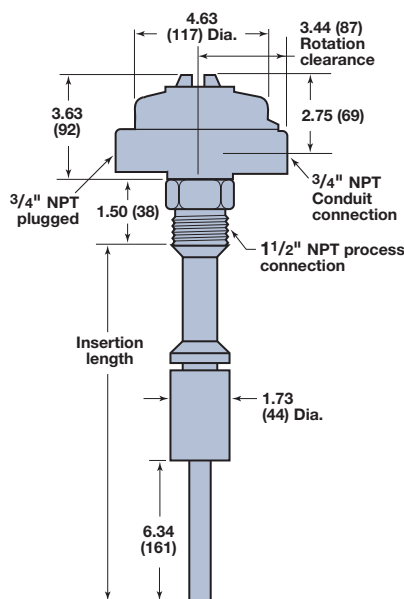

Extended Rigid Probe

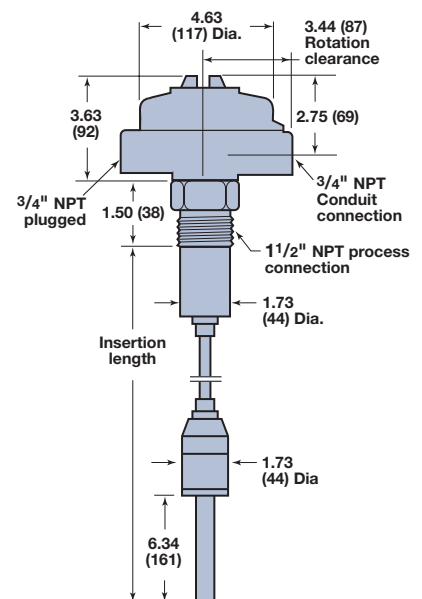

Extended Flexible Probe

INSTALLATION

IMPORTANT: Handle the instrument with great care, especially the probe. Any impact on the probe can damage the vibration system.

- Ensure that the slope angle of the material is considered when positioning the probe in the vessel.
- When using an extended version for low level alarm, mount the probe above the outlet of the vessel to avoid the probe being dragged along by the outflowing material.
- Side mounted units are best installed at an angle.
- Avoid mounting the sensor in a recess where build-up could dampen the vibration.

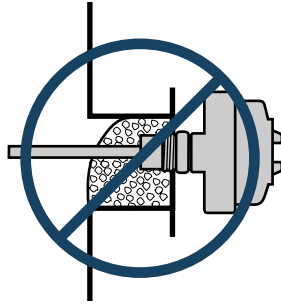

- A deflection plate is required when the probe is exposed to falling material or, in the case of a low level switch, when the drag force of the emptying material exceed the specifications.

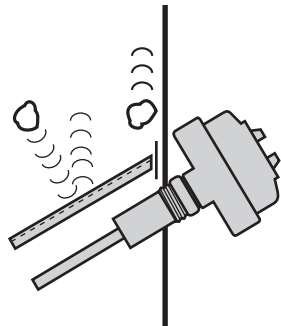

- Observe the specifications for bending force(F), torque(M) and pull force(F) as indicated below:

Standard:

$F = 100$ pounds (445 N)

$M = 63$ foot pounds (85 Nm)

Extended Rigid:

$M = 63$ foot pounds (85 Nm)

Extended Flexible:

$F = 10,000$ pounds (45 kN)

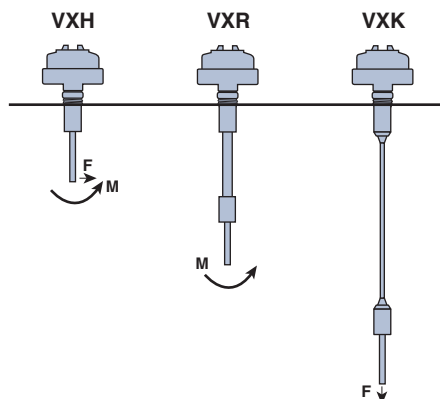

QUALITY



The quality assurance system in place at Magnetrol guarantees the highest level of quality throughout the company. Magnetrol is committed to providing full customer satisfaction both in quality products and quality service.

Magnetrol's quality assurance system is registered to ISO 9001 affirming its commitment to known international quality standards providing the strongest assurance of product and service quality available.

ESP

Expedite **S**hip **P**lan

Several Solitel Vibrating Rod Level Switches are available for quick shipment, usually within one week after factory receipt of a purchase order, through the Expedite Ship Plan (ESP).

To take advantage of ESP, simply match the

color coded model number codes (standard dimensions apply).

ESP service may not apply to orders of ten units or more. Contact your local representative for lead times on larger volume orders, as well as other products and options.

WARRANTY



All Magnetrol electronic level and flow controls are warranted free of defects in materials or workmanship for one full year from the date of original factory shipment.

If returned within the warranty period; and, upon factory inspection of the control, the cause of the claim is determined to be covered under the warranty; then, Magnetrol will repair or replace the control at no cost

to the purchaser (or owner) other than transportation.

Magnetrol shall not be liable for misapplication, labor claims, direct or consequential damage or expense arising from the installation or use of equipment. There are no other warranties expressed or implied, except special written warranties covering some Magnetrol products.

For additional information, see Instruction Manual 56-601.



5300 Belmont Road • Downers Grove, Illinois 60515-4499 • 630-969-4000 • Fax 630-969-9489 • www.magnetrol.com
145 Jardin Drive, Units 1 & 2 • Concord, Ontario Canada L4K 1X7 • 905-738-9600 • Fax 905-738-1306
Heikensstraat 6 • B 9240 Zele, Belgium • 052 45.11.11 • Fax 052 45.09.93
Regent Business Ctr., Jubilee Rd. • Burgess Hill, Sussex RH15 9TL U.K. • 01444-871313 • Fax 01444-871317

Copyright © 2006 Magnetrol International, Incorporated. All rights reserved. Printed in the USA.
Magnetrol and Magnetrol logotype are registered trademarks of Magnetrol International.

Performance specifications are effective with date of issue and are subject to change without notice.

BULLETIN: 56-101.7
EFFECTIVE: November 2006
SUPERSEDES: January 2005