

**PREDICTIVE
MAINTENANCE
SYSTEMS**

PROTECTING
YOUR
INVESTMENT

SENTURION

SENSORS

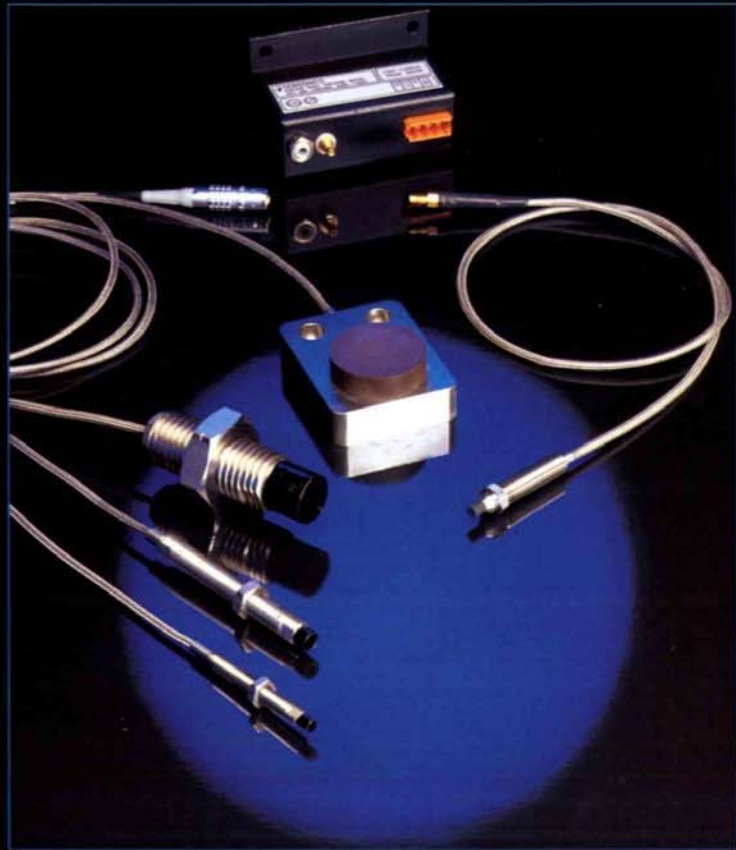

EDDY CURRENT PROBES FOR INDUSTRY



SENTURION

Designed for Strength, Reliability and Accuracy

INDUSTRIAL EDDY CURRENT PROBE SYSTEMS

How Eddy Current Probes work

Eddy current probe systems are made up of a coil, embedded in the tip of the probe, a separate driver unit and an interconnecting 'tuned' length of cable.

The principle of operation, as the name implies, depends upon the eddy currents set up in the surface of the target material.

The coil is supplied with a constant r.f current from the remote eddy probe driver, which sets up an electro-magnetic field between the tip and the observed surface.

Any electrically conductive material within this electro-magnetic field, ie. the target material, will have eddy currents induced in it's surface. The energy absorbed from the electro-magnetic field to produce these eddy currents will vary the strength of the field, and hence the energising current, in proportion to the probe target distance. Such changes are sensed in the driver where they are converted to a varying voltage signal. The whole probe, extension cable and driver system relies for it's operation on being a tuned circuit and as such is dependant on the system's natural frequency. Thus each system is set up for a fixed electrical/cable length. Eddy probe systems are usually supplied with 2,5,9 or 14 metre total cable lengths.

SENTURION eddy current probes have been designed to be the most robust available and are ideally suited to a vast range of industrial applications.

 **SENSONICS**

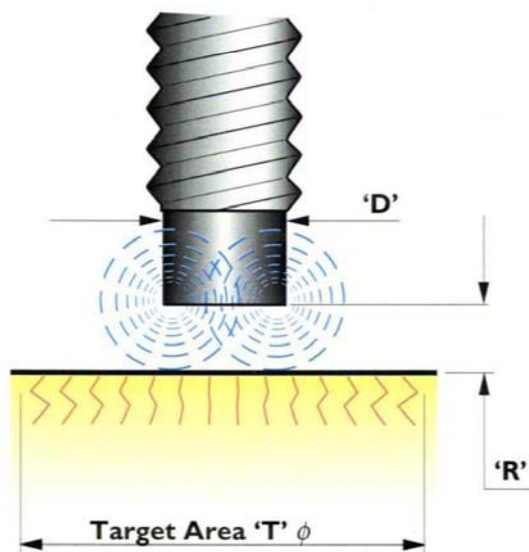

Linear Measuring $\equiv \frac{1}{3} \times \text{Probe Tip } \phi \text{ 'D'}$
Range 'R'

Target Area $\phi \text{ 'T' } \equiv 2 \times \text{Probe Tip } \phi \text{ 'D'}$

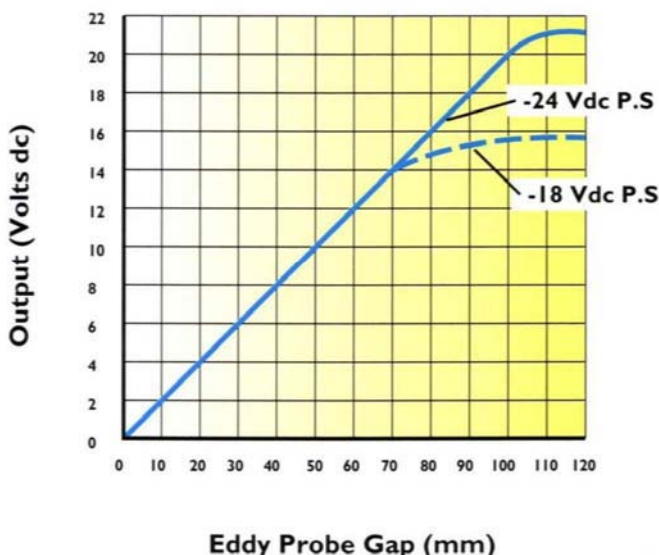

Senturion probes are calibrated using a standard target of steel. Other types of conductive material may affect the sensitivity of the system.

STRAIGHT MOUNT PROBES

- Robust stainless steel threaded case in various lengths and threads
- Peek encapsulated tip impervious to oil or water ingress
- Suitable for forward or reverse mounting in suitable bracketry (see Sensonics leaflet L134)
- Supplied with free running locknut
- Intrinsically safe options available
- Choice of cable lengths with or without armouring connecting directly to driver unit or to extension cable
- Operating temperature range, -30°C to +180°C

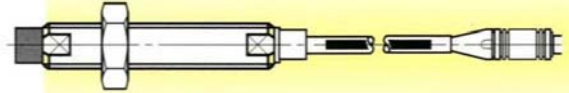

Probe Type	Measuring Range	Tip Diameter	Data Sheet Reference
PRS O2	2.5 mm	5 mm	L156
PRS O4	4 mm	8 mm	L157
PRS O8	8 mm	20 mm	L158

REVERSE MOUNT PROBES

- Robust stainless steel threaded case with integral locknut
- Suitable for reverse mounting into bracketry or Sensonics probe housing
- Peek encapsulated tip impervious to oil or water ingress
- Intrinsically safe options available
- Choice of cable lengths with or without armouring connecting directly to driver unit or to extension cable
- Operating temperature range, -30°C to +180°C



Probe Type	Measuring Range	Tip Diameter	Data Sheet Reference
PRR O4	4 mm	8 mm	L159

DISC PROBES

- Robust stainless steel body with 2 or 3 mounting holes
- Peek encapsulated tip impervious to oil or water ingress
- Range of standard bracketry available, for mounting (see leaflet L134)
- Choice of cable lengths with or without armouring connecting directly to driver unit or to extension cable
- Operating temperature range, -30°C to +180°C

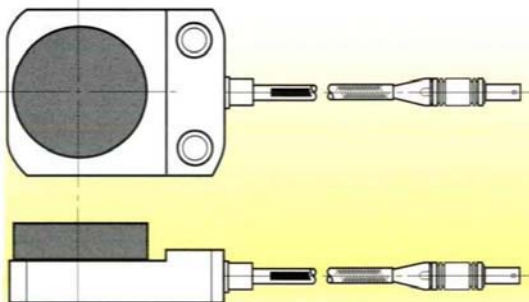

Probe Type	Measuring Range	Disc Diameter	Data Sheet Reference
PRD O2	2.5 mm	5 mm	L160
PRD O4	4 mm	8 mm	L161
PRD O8	8 mm	20 mm	L162
PRD I2	12 mm	25 mm	L163
PRD I8	18 mm	40 mm	L164

* The probes shown on this leaflet form the 'Senturion' standard range.
If you do not see what you require please call the Sensonics technical sales department.

EXTENSION CABLES



Available in various 'tuned' lengths up to 18m. With or without stainless steel overbraid armouring.

Various connectors, oversheaths and sealing glands are available, and supplied fitted.

Ordering details appear on relevant probe data sheets

DRIVER UNITS

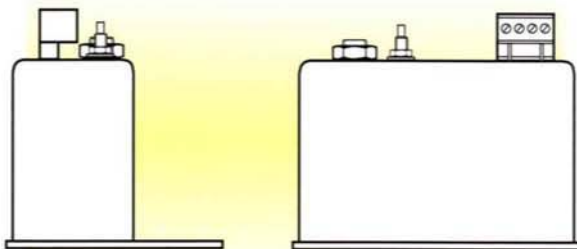

- Compact design either baseplate or DIN rail mounted.
- Robust connector supplied for convenient connection/disconnection
- Electrically isolated case
- Four connections per box required (-24V, 0V, Signal and 0V)
- Operating temperature, -30°C to +90°C

Ordering details appear on relevant probe data sheets

PROBE HOLDER

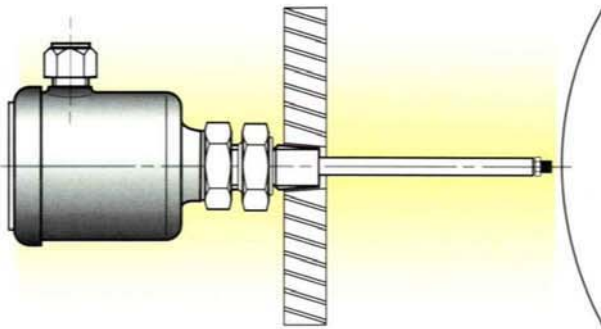

Enables the replacement of probes without recalibration.

- Available in aluminium alloy or stainless steel enclosure
- Internal adjustment of probe insertion depth
- Sealed at both cable and probes entry points
- Up to 300mm maximum insertion depth

For details refer to data sheet LI65

DRIVER HOUSING

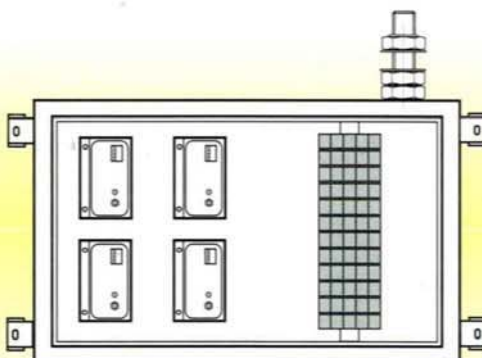

- Sheet steel enclosure with removable gland plates and lockable door
- Sealed to IP65
- Capacity for 2, 4, 6 or 9 drivers
- Fully wired with terminals fitted

Housing Type	No of Drivers	Size of Enclosure
DH 2	2	240 x 240 mm
DH 4	4	240 x 360 mm
DH 6	6	480 x 360 mm
DH 9	9	480 x 480 mm

For details refer to data sheet LI66

STANDARD FEATURES

OF SENTURION

EDDY CURRENT PROBES

- Rugged Industrial Design
- Conforms to API 670
- Operating temperature, -30°C to 180°C, PROBE
- Operating temperature, -30°C to 90°C, DRIVER
- DIN rail mounted driver units available
- Wide power supply tolerance (-18 to 30Vdc)
- Sealed to IP 65, (PROBES)
- Frequency range DC - 10kHz
- Stainless steel case
- Radiation resistant
- Calibration adjustment $\pm 5\%$
- Temperature sensitivity $\leq 5\%$ at 120°C (PROBE)
- Temperature sensitivity $\leq 5\%$ at 90°C (DRIVER)
- Output impedance less than 50 ohms
- Effect of target magnetism, less than 5% at 110 μ t
- Stainless steel overbraid on cable
- Interchangeability, less than 5% error

Ancillary Equipment

Sensonics can offer a full range of bracketry, glands and other installation aids, as well as an install and commission service.

Please call for details.

Shaft axial position
measurement.
thrust wear,
differential expansion

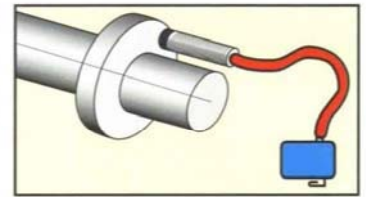

Shaft radial vibration,
eccentricity, relative
vibration, X & Y
monitoring

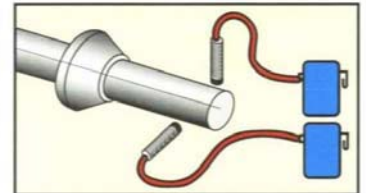

Speed, zero speed

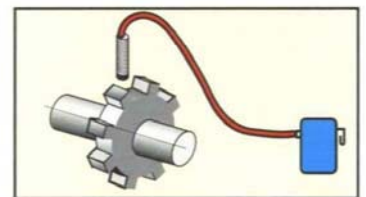

Phase reference
angle, reverse
rotation

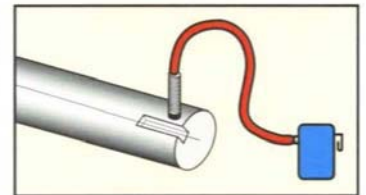

Tapered shaft
axial position,
(4, 2 & single
probe systems)

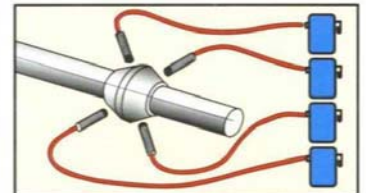

Shaft axial position
using triangulation
patterns

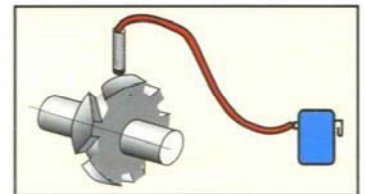

Alignment

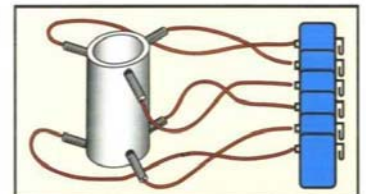

Reciprocating
compressor
Rod Drop
monitoring

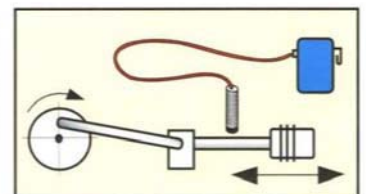

NB

Due to Sensonics' policy of constant improvement, designs may be subject to alteration without notification.

PREDICTIVE MAINTENANCE SYSTEMS

KEEPING
INDUSTRY
TURNING



OTHER PRODUCTS IN THE SENSONICS RANGE

- Velocity Transducers
- Accelerometers
- LVDT's & RVDT's
- Portable predictive maintenance systems
- Signal conditioning systems
- On line vibration monitoring
- Seismic Sensors

SENSONICS CAN ALSO UNDERTAKE

- Feasibility studies
- Installation and commissioning (turnkey projects)
- System integration
- Condition monitoring surveys and contracts
- Diagnostic services

Local Representation:



In a commercial environment of increasingly stringent regulations on processes, tighter budget constraints combined with increased quality controls, closer government scrutiny of operations and ever-more fierce competition from many corners of the globe, there has never been a more appropriate time for industry to adopt systems, procedures and policies that ensure the competitive advantage as well as conformity to the wide array of international standards.

Sensonics predictive maintenance technology should be a vital part of your company's strategy to enable your operations to meet the challenges of the next decade - and beyond.

Sensonics Ltd
Northbridge Road
Berkhamsted
Hertfordshire
HP4 1EF
England

Telephone:
+44 (0)1442 876833
Facsimile:
+44 (0)1442 876477
Email:
sales@sensonics.co.uk
www.sensonics.net

SENSONICS

If you are at all unsure about any application of Eddy Current Probes please do not hesitate to call our technical sales department, who will be delighted to offer advice without obligation.



Cert. No. FM26920