

NEW

"56" series for
lower temperature
applications

Modline® 5 Infrared Thermometers



Non-contact Standalone Temperature Sensors
to Serve a Wide Range of Applications

IRCON



Superior temperature accuracy and smart features to serve a wide range of applications

52 Series:	5R Series:	5G Series:	56 Series:
932° - 5432° F 500° - 3000° C .85 - 1.1 μm	1112° - 5432° F 600° - 3000° C .75 - 1.05 μm and 1.0 - 1.1 μm (2-Color)	482° - 3632° F 250° - 2000° C 1.6 μm	122° - 1472° F 50° - 800° C 2 μm
High-temperature sensors ideal for processes such as metal forging, annealing, hardening, and foundries	Dual-detector high-temperature sensors for difficult processes such as furnaces, kilns, molten metals, and thin wires or rods	1.6 micron mid-temperature sensors ideal for ferrous/non-ferrous metal treating applications	NEW SERIES! 2 micron sensors ideal for spot welding or induction heating as well as low-temperature rubber, thick plastic, or textile applications

Modline® 5

If reliable, accurate temperature measurement and easy operation are critical to your process, look to the features of the Modline 5 series

Outstanding Performance

Like the long line of superior, industrial-strength IRCON infrared thermometers before it, Modline 5 is a top performer. Designed to serve a variety of applications and withstand hostile environments with accuracy and repeatability, you can rely on Modline 5 with your process.

Intelligent, Assured Accuracy

With Modline 5, temperature should no longer be in question when monitoring your process. Modline 5 thermometers include System Health Check, calibration check and other smart features that help verify optimal operation. It will automatically detect that it is performing correctly, or let you know where it is not. Even the lens window can automatically monitor itself to assure it is clear of debris!

Small, Durable and Capable

Designed to withstand long terms in harsh environments, all components of the sensor are contained within a sealed, stainless steel NEMA 4 (IP65) enclosure. With a diameter less than 2.25", it is one of the most capable small infrared thermometers on the market.

Flexible Control Possibilities

With abilities to function both standalone and networked, standard I/O signal interfaces (both analog and bi-directional RS-485 digital) enable operation with other systems and devices. Achieve insight, quality and efficiency like never before with Modline 5 sensors integrated with your process.

Simple Installation and Operation

It all adds up to low overall costs. Beyond being a top performer in terms of reliable accuracy and flexible control possibilities, count on Modline 5 being easy to operate:

- Precise focus takes only a twist
- Free software simplifies configuration and lets you monitor sensor operation remotely
- Match Function takes the guesswork out of setting emissivity
- Sensor Health Check and Dirty Window Detector option automatically monitors sensor conditions so that you will not have to
- Accessories are designed to allow configuration and focus changes without having to physically remove the sensor

New 56 Series highlights:

- 2 Micron Unit
- Lower Temperature Range (down to 50°C)
- Thermo-Electrically Cooled Detector
- Internal Self-Calibration Feature

Precise focus, rear-adjustable optics

Focus precisely on target using a small spot size by twisting the back portion of the sensor housing

Automatic Sensor Health Check

Built-in 'smart' electronics assure accuracy

Emissivity Match function

If you already know the temperature, the sensor can determine the emissivity

2-Color dual detector models available

For handling tough temperature measurement jobs

Dirty Window Detector (DWD) option

Assure accuracy and reduce maintenance time

Smart line of accessories

Simplify operation and assure a long sensor life

Durable, sealed, stainless steel enclosure

NEMA 4 (IP65) rated enclosure fully protects electronic components – even the display and keypad

Built-in, thru-the-lens Visual or Laser sighting

See exactly what the sensor measures

Flexible control options

Integrate Modline 5 sensors with your process

Free PC software for remote setup, configuration and monitoring provided with each sensor

Sensor Features:

The Modline 5 series offers a small sensor with big capabilities:

Intelligent Design

- High resolution Modline 5 optics and adjustable focus enable precise targeting. Distant objects can be measured using a very small focal area or “spot” size.
- Target sighting is precise and easy – Two built-in, thru-the-lens options are available: Visual or Laser. Adjust focus by turning the rear portion of the sensor, which can be locked into position
- A line of flexible accessories simplify Modline 5 installation and operation and replacement of older equipment. All sensor settings and focus can be adjusted even with all Modline 5 accessories installed (see page 6 for more detail).



Assured Accuracy

A System Health Check feature offers tools that help start-up troubleshooting, instrument maintenance and assuring accuracy.

System Health Check refers to self-diagnostic capabilities (including calibration check) that are built into all Modline 5 sensors. When activated, the sensor electronics are verified to instrument specifications set at the factory. If any issues are detected, the sensor will issue an alarm (on the sensor display and through output signals) with information regarding the nature of the error.

System Health Check can be programmed to automatically check the system at regular intervals, and can be initiated from remote sources connected through the sensor cable.

With the 56 Series, internal self-calibration can also occur automatically, if necessary.

Combine System Health Check with the Dirty Window Detector (DWD) option and other Modline 5 accessories to assure greatest temperature measurement accuracy.

Unique Emissivity Match Function

What can be a complex and frustrating process – determining emissivity to achieve correct temperature readings – is simplified with the Modline 5 Match Function. Simply aim the sensor at the target and adjust settings to the known temperature – Emissivity settings will be automatically adjusted.

Sensor Options:

Beyond having a selection of lenses and temperature and spectral ranges to choose from, each Modline 5 sensor can be ordered with the following helpful options:

Dirty Window Detector (DWD)

All infrared sensors will experience some loss of measurement accuracy if the window becomes obscured due to dust, condensation, or other contaminants.

The Modline 5 series offers an innovative Dirty Window Detector (DWD) option to address this matter. The DWD automatically detects if build-up on the window is present and sends an alarm output to notify you.

Even in relatively clean environments where fluctuations in signal accuracy can have an extreme effect on a reading, the DWD provides added insurance that the temperature measurement is accurate.

A traditional solution for preventing build-up is to install an air purge accessory, designed to continuously blow compressed air across the sensor lens or window. While this solution typically works well, there are cases where it is not always practical, such as when sensor mounting space is limited or when an air source is unreliable or expensive to install.

If you require multiple levels of assurance, the small Modline 5 APA air purge is designed to function with the Modline 5 sensor with the DWD option installed.

Thru-The-Lens Laser Sighting

With the built-in Laser Sighting option, the size of the laser spot represents the detection area or “spot” size.

It is a helpful tool for verifying the precise focal area where temperature will be measured, and for focusing on targets that are difficult to see.

The laser is turned on and off by pressing a button on the rear display. If the sensor is mounted in a difficult-to-reach location, the laser can also be triggered on and off by remote switch or other devices connected through the sensor cable.

Calibration Transfer Standard

The convenience of on-site sensor calibration testing is possible with the Transfer Standard option. Supplied with calibration software and NIST-traceable calibration results, a Transfer Standard Modline 5 sensor can be a tool against which all your other Modline 5 sensors are measured (see page 5 for detail).



The Dirty Window Detector option protects the sensor lens, and automatically monitors and informs you if debris has built up on it's window. Many customers find this option to be a great maintenance time saver.

(patent number 5812270)



The Laser Sighting option makes it easy to focus the sensor and attain ideal spot size on targets that are difficult to see. Simply aim and twist the rear section of the sensor to achieve desired focus.

Sensor Setup and Configuration Options:

The Modline 5 series offers you numerous configuration and interface options, enabling you to flexibly adapt your temperature monitoring strategy with your control requirements. Whether your need simple temperature display or demand complex systems interoperability, Modline 5 solutions can help you reach your goals.

Rear Display Controls

All settings can be controlled through the keypad on the back of the sensor. The bright alphanumeric LED display provides menu prompts; temperature display in °C or °F; and alarm prompts if critical conditions exist. The display can be viewed clearly through a protective window that comes standard with the unit.

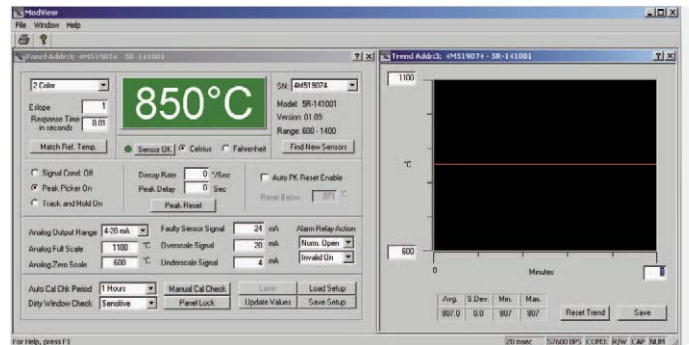

ModView Configuration Software

ModView Configuration Software is a PC-based setup and monitoring tool supplied with every Modline 5 sensor. It enables communication between the PC and a sensor through bi-directional RS-485 digital communications:

- All sensor parameters can be viewed and adjusted through a PC, using a single window “dashboard”
- Settings files can be saved and re-used for configuring other Modline 5 sensors
- A trend screen provides real-time, graphical display of temperature readings
- Temperature data can be recorded over time and exported as a CSV file for archiving, trending and reporting purposes

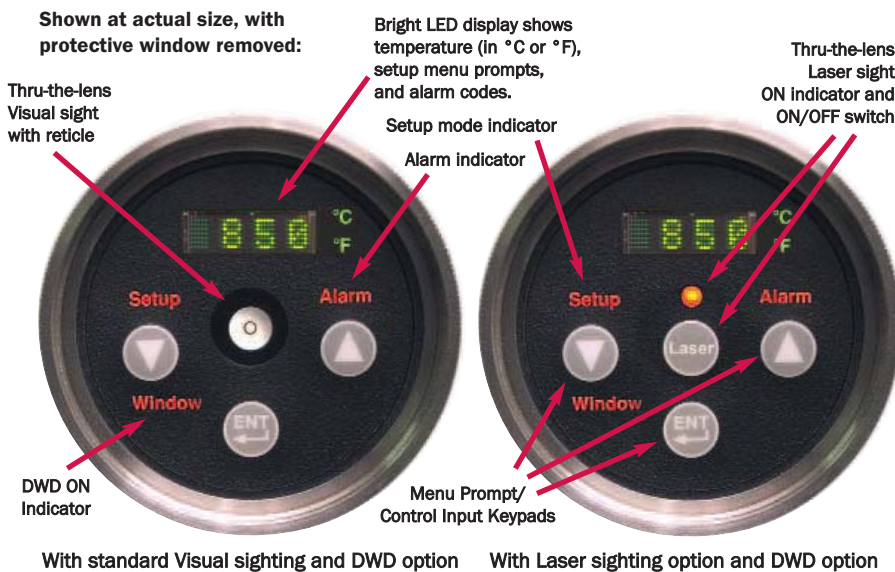

Digital Panel Meter (DPM)

The DPM makes it simple to remotely control and monitor Modline 5 sensors mounted in hard-to-reach or hazardous locations. More than a just a temperature display - it is a complete Modline 5 sensor configuration and monitoring tool, including System Health Check capabilities.



Menu commands entered on the sensor's on-board display can also be entered through the DPM, connected via RS-485 serial communication. All Modline 5 menus are pre-loaded on the DPM so that it is ready to communicate with a sensor after wiring.

An optional relay board can be ordered to provide four user-configurable temperature alarms. The DPM is powered separately from the Modline 5 and requires 85 to 250 VAC 50/60 Hz power.

Multi-Sensor Interface (MSI)

Centrally and simultaneously monitor multiple temperature points and alarms, and remotely configure and adjust settings for up to twelve Modline 5 sensors – on the production floor, over your company network or the Internet.

The MSI incorporates a 10" NEMA 4 display with touch keys, processing capabilities and multiple communication ports, enabling greater process monitoring and control flexibility.



The system comes pre-programmed to function with Modline 5 sensors, can capture and save trend data, and can communicate with process control, PLC and SCADA systems using RS-232, 485, or ethernet.

Modline 5 System Configuration Possibilities:

ModView Configuration Software

(On PC on production floor or at remote location)



- Configure sensor remotely
- Display temperature
- Display temperature trend data
- Monitor Sensor Health Check status
- Archive trend data as CSV files

Digital Panel Meter (DPM)

(Panel mounted on production floor)



- Configure sensor remotely
- Display temperature
- Display temperature alarms

Multi-Sensor Interface (MSI)

(Panel mounted on production floor)

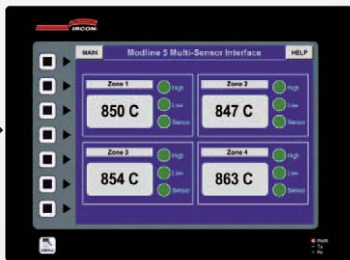

- Configure sensors remotely
- Display temperatures
- Display temperature alarms
- Display temperature trend data

- Monitor Sensor Health Check status
- Archive trend data as CSV files
- Display temperatures / change sensor settings via Network or Internet using Built-In Web Server

PLCs
PCS / Scada
Internet
Company Network
Other PCs
Printer

... and other systems where external control is required

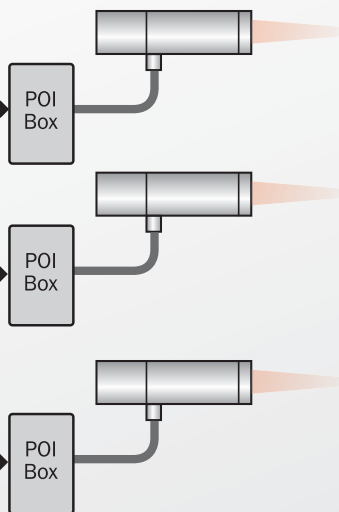

Configure and monitor up to twelve Modline 5 sensors simultaneously

Sensor Power and Interface Options:

There are three options to power and connect a Modline 5 sensor:

Modline 5 POI (Power/Output/Input) Box:

The Modline 5 POI Box combines a Terminal Strip Plate and Switching Power Supply (described below) within a NEMA 4 rated enclosure with conduit connection ports. It enables easy wiring of the Modline 5 sensor cable, overall system CE certification compliance, and connectivity with external systems.

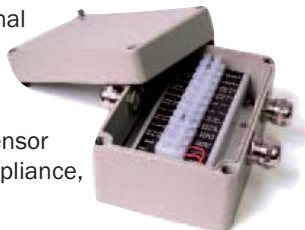

Modline 5 Terminal Strip Plate (TSP) and Switching Power Supply:

If you want to use your own enclosure and continue to assure CE compliance of your Modline 5 system, a Switching Power Supply and Terminal Strip Plate (similar to that supplied with the POI Box above) may be purchased separately. The power supply provides 24 VDC/ 635 mA output and requires 100 to 240 VAC 50/60 Hz input. The Terminal Strip Plate enables easy wiring of the sensor cable, connectivity with external systems and is required to maintain Modline 5 system CE compliance.



Modline 5 Terminal Strip Plate (TSP):

If you would prefer to use your own enclosure and power supply, the Modline 5 Terminal Strip Plate is sold independently.



Sensor Calibration Testing:

Modline 5 Transfer Standard Sensors with ModView Calibration Software enable the convenience of on-site calibration

For operations that require frequent sensor calibration testing due to regulatory or process requirements, IRCON offers Modline 5 Transfer Standard units.

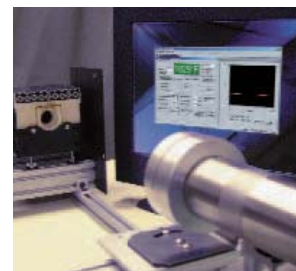

Modline 5 Transfer Standard sensors are validated to extremely high precision (traceable to NIST) at our factory, and supplied with a detailed calibration certificate.

Using a Modline 5 Transfer Standard sensor with ModView Calibration Software (included with each Transfer Standard unit purchase) and a blackbody source, you can test and calibrate other Modline 5 sensors on-site to assure the same levels of accuracy. ModView Calibration Software may be purchased independently.

IRCON also offers a range of blackbody source products and sensor calibration testing services -- conducted at your location or with the sensor(s) shipped to an IRCON service center near you.

Sensor Specifications

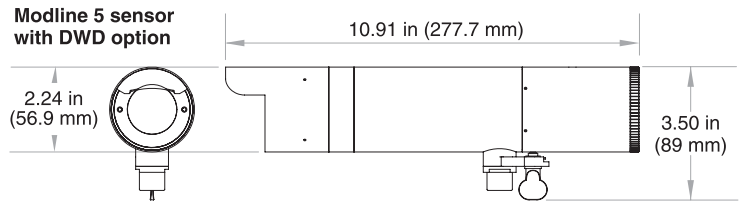
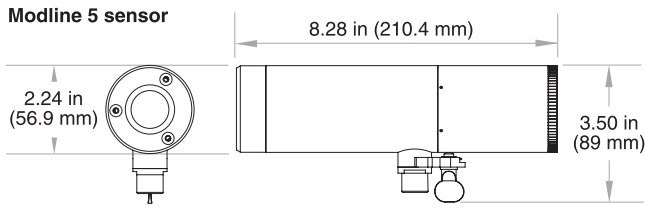

	52 Series	5R Series (Ratio)	5G Series	56 Series
Performance				
Spectral Region	0.85 - 1.1µm	0.75 - 1.05µm; 1.0 - 1.1µm (ratio mode) 1.0 - 1.1µm (single color mode)	1.6 µm	2.0-2.8 µm (56-0315 only) 2.3-2.6 µm (56-0515, 56-0815)
Accuracy @ 25 °C	0.3% of reading, +1 °C	0.5% of reading, plus 2 °C	0.3% of reading, +1 °C	0.3% of reading +1 °C, or 2 °C (whichever is greater)
Response Time	6.6ms	10ms	6.6ms	10ms
Emissivity	0.100-1.000	0.100 -1.000 (single color mode)	0.100 -1.000 *	0.100 -1.000 *
E-slope range	n/a	0.800 - 1.200 (ratio mode)	n/a	n/a
Repeatability	@ 25 °C 0.1% of full scale, plus 1 digit (all models)			
Signal Processing	Peak Picker and Track & Hold (all models)			
Sighting	Internal, thru-the-lens Visual (standard) or Laser (optional)			
* Emissivity span is limited to 0.3 -1.0 for the first 55 °C (100 °F) for all temperature ranges				

Inputs/Outputs

Analog Output (scalable)	0-20ma, 4-20ma with 600 ohm Max. load
Analog Input	4 - 20mA (emissivity or e-slope)
Relay Output	System Alarm (24 VAC/DC @1 amp resistive)
Digital Input/Output	RS-485 (user selectable, 57.6K max)
Power Requirements	24 VDC +/- 5%, 8 Watts Max.

Operating Ambient Temperature

Without Cooling	0 to 55 °C / 32 to 130 °F
With Air Cooling	0 to 105 °C / 32 to 220 °F
With Water Cooling	0 to 200 °C / 32 to 400 °F
Storage Temperature	20 to 70 °C / -4 to 60 °F
Cable Temperature	200 °C (max) / 392 °F (max)



Physical / Environmental

Environmental Rating	NEMA 4 (IP65)
Weight (sensor only)	1.4 kg (3.1 lbs)
Humidity	10 to 90% non-condensing
Shock	IEC 68-2-27
Vibration	IEC 68-2-6

Product Compliance

The Modline 5 POI box and TSP plate meet the following standards:
 EN 61010-1:2001, Safety Requirements
 EN 55011:1998, Amend. A1:1999 Emissions for Industrial Equip.
 EN 61326-1:1997 Immunity Test Req. for Industrial Locations
 UL 61010B-1, 2003, General Requirements
 CSA C22.2 No. 1010.1, 1997, General Requirements

Accessories

IRCON Modline 5 sensor hardware accessories are designed to simplify installation and maintenance, enable greater operator safety, and assure sensor accuracy and protection while operating in harsh environments.

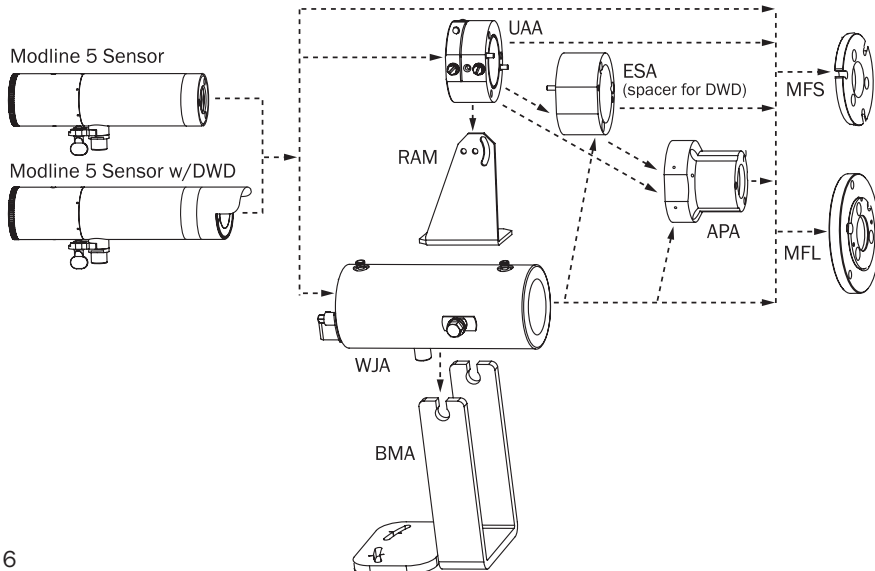

WJA (Water Jacket Accessory) and BMA (Base Mount Adapter)

The Water Jacket Accessory (WJA) protects a Modline 5 sensor from extreme ambient temperatures.

Circulating water or air through the jacket lining helps to maintain a constant and cool sensor operating temperature, assuring greater accuracy and long term reliability.

The adjustable Base Mounting Adapter (BMA) can be used for mounting the WJA. If flange mounting is preferred, the Mounting Flange - Large (MFL) or Mounting Flange - Small (MFS) can also be used.



Sensor Selection and Ordering

The Modline 5 sensor model number, lens, cable length and any factory installed options you prefer must be specified at the time you place your order

SENSOR AND LENS ORDERING NUMBERS:

	Temperature Range		Spectral Range	Lens and Optical Resolution			Primary Applications	
				(One lens per sensor. See diagram below)				
52-1410	500 to 1400° C	932 to 2552° F	0.85 - 1.1 μm	2A or 2B or 2C	D/100	D/90	D/80	High Temperature Processes Metal forging, annealing, hardening, foundries, and incandescent processes
52-2020	600 to 2000° C	1112 to 3632° F	0.85 - 1.1 μm	D/200	D/180	D/160		
52-3024	750 to 3000° C	1382 to 5432° F	0.85 - 1.1 μm	D/240	D/216	D/192		
5R-1410	600 to 1400° C	1112 to 2552° F	0.75 - 1.05 μm; 1.0 - 1.1 μm	RA or RB or RC	D/100	D/90	D/80	Difficult High Temperature Processes Molten metals, small wires, small rods, vacuum furnaces and kilns
5R-1810	700 to 1800° C	1292 to 3272° F	0.75 - 1.05 μm; 1.0 - 1.1 μm	D/100	D/90	D/80		
5R-3015	1000 to 3000° C	1832 to 5432° F	0.75 - 1.05 μm; 1.0 - 1.1 μm	D/150	D/135	D/120		
5G-1007	250 to 1000° C	482 to 1832° F	1.6 μm	2A or 2B or 2C	D/75	D/67	D/60	Mid to High Temperature Processes Ferrous and non-ferrous metal treating
5G-1415	300 to 1400° C	572 to 2552° F	1.6 μm	D/150	D/135	D/120		
5G-2024	350 to 2000° C	662 to 3632° F	1.6 μm	D/240	D/216	D/192		
56-0315	50 to 300° C	122 to 572° F	2.0 - 2.8 μm	6A or 6B or 6C	D/150	D/135	D/105	Mid and Low Temperature Processes Spot welding, induction heating, thick plastic, rubber & textiles, wire coating
56-0415	100 to 400° C	212 to 752° F	2.3 - 2.6 μm	D/150	D/135	D/105		
56-0815	200 to 800° C	392 to 1472° F	2.3 - 2.6 μm	D/150	D/135	D/105		

FACTORY-INSTALLED SENSOR OPTIONS:

Each item below must be specified with each sensor ordered.

Cable Length

The length of the interconnecting cable between a Modline 5 sensor connector port and POI Box / Terminal Strip Plate may be tailored to your requirements up to a maximum of 350 feet (107 meters).

Laser Sight

The built-in thru-the-lens Laser sight option must be specified at the time of order – unless specified, Visual sight will be installed.

Dirty Window Detector

The DWD option (supplied with ESA accessory) requires factory installation – unless specified, a sensor without DWD will be shipped.

Transfer Standard

Calibration Transfer Standard model sensors, supplied with ModView Calibration Software will be shipped with this option selected. ModView Calibration Software may be ordered independently without a Transfer Standard sensor. See pages 3 and 5 for more detail.

Formula to determine measurement area spot size:

$$d = D / F$$

- d = Diameter of desired spot size at focal point
- D = Distance from front of sensor to focal point (w/DWD, add 2.6" or 66mm from hood tip)
- F = Optical Resolution factor of sensor model and lens combination

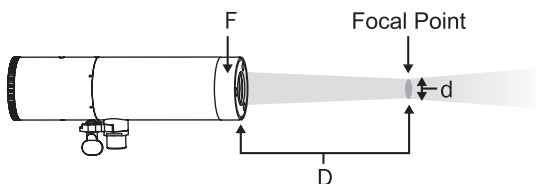

Lens	Focusing Range
2A	330 mm (13") to infinity
2B	152 to 305 mm (6 to 12")
2C	57 to 70 mm (2.25 to 2.75")
RA	330 mm to infinity (13" to infinity)
RB	178 to 355 mm (7 to 14")
RC	57 to 70 mm (2.25 to 2.75")
6A	305 mm (12") to infinity
6B	152 to 305 mm (6 to 12")
6C	44 to 57 mm (1.75 to 2.25")



RAM (Right Angle Mount)

The RAM bracket offers a convenient way to mount a Modline 5 sensor to a surface. The UAA (described below) is required to attach the sensor to the RAM.



UAA (Universal Adapter Accessory)

The UAA clamps around a Modline 5 sensor, and can be used to mount it to a RAM bracket (described above), a tripod, or any device using 1/4-20 UNC threaded mounting hardware.



ESA (Extension Sleeve Adapter)

The ESA serves as a spacer, and is required for many accessories (APA, MFL, MFS) used with Modline 5 Dirty Window Detector (DWD)-equipped sensors. The ESA is supplied with the purchase of Modline 5 sensors equipped with the DWD option.



MFL (Mounting Flange - Large)

The MFL can be mated to a Modline 5 sensor by bolting it to the Universal Adapter Assembly (UAA), Air Purge (APA), or Water Jacket (WJA) accessory. It has a bolt pattern that also matches other IRCON products.



MFS (Mounting Flange - Small)

The smaller MFS mounting flange is available, designed with a bolt pattern to match many infrared thermometers on the market. Like the MFL, the MFS can be mated to a Modline 5 sensor by bolting it to the Air Purge Accessory (described below).



APA (Air Purge accessory)

This specially designed air purge is used to help keep Modline 5 sensor optics clean. This unit mounts to the front of the sensor and requires the UAA or WJA to mount it in place.

Experience the Difference

Count on IRCON to help you find solutions to your temperature monitoring challenges. IRCON offers on-site equipment demonstrations, consulting, training and other arrangements to help you experience our products and prove their ability to meet your needs.

About IRCON

If you are looking for solutions to difficult temperature measurement and monitoring challenges, IRCON is the company to call. IRCON offers a product range and experience that are unmatched in the industry.

In business since 1962, IRCON products perform with accuracy and repeatability in the harshest and most volatile conditions requiring precise temperature measurement and control.

Our solutions are designed to suit a wide variety of applications, with a product line capable of measuring temperatures from -50° to 6500° F (-50° to 3500° C).

Whether you do research or are in the business of manufacturing or processing metals, glass, plastics, ceramics, paper, textiles, chemicals, packaging, food or pharmaceutical, chances are IRCON has a solution to address your situation.

Global Service and Support Solutions

Beyond leading-edge products and expertise, you can count on IRCON for a variety of valuable services and support options, including:

- Product warranty programs
- Fixed repair cost programs
- On-site repair and preventative maintenance
- On-site technical consulting and troubleshooting
- Operator training
- Sensor re-calibration and certification service

Through our network of nearly 150 distributors around the globe, and service centers in North America, Europe, and Asia – no matter where you are, IRCON specialists are near you to assist.

For additional information, please visit our web site, contact an IRCON specialist in your area, or submit a request at http://www.ircon.com/tech_request

IRCON Inc is a Spectris company – a leading global supplier of precision instrumentation and controls. For additional information, please visit <http://www.spectris.com>



NIST Calibration Provider

To find the IRCON office or products representative nearest you, please visit <http://www.ircon.com/rebs>

World Headquarters:

IRCON Inc

(Serving North and South America)

7300 North Natchez Avenue

Niles, Illinois, USA 60714

Phone: 847 967 5151

Toll Free: 800 323 7660 (USA and Canada)

Fax: 847 647 0948

E-Mail: info@ircon.com

European Headquarters:

IRCON BV

(Serving Europe, Middle East, Africa and Russia)

Databankweg 6c

3821 AL, Amersfoort, The Netherlands

Phone: 31 33 450 4321

Fax: 31 33 450 4320

E-Mail: info@ircon.nl

International Offices:

IRCON China

Spectris China Ltd.

Unit 101, Xin An Plaza, Building 13

No. 99 Tianzhou Road

Shanghai 200233 P.R. China

Phone: 86 21 6113 3735

Fax: 86 21 6113 3788

IRCON India

Spectris Technologies Pvt. Ltd.

14, Kasturba Gandhi Marg,

6th Floor, Ambadeep Bldg

New Delhi-10001 India

Phone: 91 11 5152 0625

Fax: 91 11 2332 2859

IRCON Japan

Spectris Co., Ltd.

1F JP Kaji-cho Bldg.

3-5-2 Kandakaji-Cho

Chiyoda-ku

Tokyo 101-0045 Japan

Phone: 03 5298 8170

Fax: 03 3255 8154

IRCON Korea

Spectris Korea Ltd.

8F, Turbotech B/D 16-6 Soonaedong, Bundang-Gu

Seongnam-City, Gyunggido

463-825 Korea

Phone: 82 31 786 0834

Fax: 82 31 786 0833

IRCON Singapore

Spectris PTE, Ltd.

31, Kaki Bukit Road 3

#06-04/05 Techlink

417818 Singapore

Phone: 65 6846 4991

Fax: 65-6846 4981

